

VELVAC MODEL "2025", "2030 "AND "REVOLUTION" MIRROR ASSEMBLIES

INDEX

DESCRIPTION

PAGE NO.

GENERAL MIRROR SPECIFICATIONS

GENERAL MIRROR SPECIFICATIONS AND MIRROR GLASS REPLACEMENT KIT NUMBERS..... pg 1

MOUNTING INSTRUCTIONS:

"2025" MIRROR ASSEMBLY WITH STANDARD BASE (HEATED/REMOTE CONTROL) (REQUIRING WIRE HARNESS FROM MIRROR TO SWITCH)..... pg 2

"2025" MIRROR ASSEMBLY WITH STANDARD BASE (HEATED/REMOTE CONTROL) (DIRECT WIRING FROM MIRROR TO SWITCH)..... pg 3

"2030" MIRROR ASSEMBLY WITH BUS ARM/BASE (HEATED/REMOTE CONTROL) (REQUIRING WIRE HARNESS FROM MIRROR TO SWITCH)..... pg 4

"REVOLUTION" MIRROR ASSEMBLY..... pg 5 & 6

WIRING DIAGRAMS:

REMOTE CONTROL/HEATED MEDIUM FLAT GLASS MANUAL/HEATED FULL CONVEX..... pg 7

REMOTE CONTROL/HEATED FULL FLAT GLASS MANUAL/HEATED AUXILIARY CONVEX..... pg 8

REMOTE CONTROL/HEATED FULL FLAT GLASS (INVERTED) MANUAL/HEATED AUXILIARY CONVEX (INVERTED)..... pg 9

REMOTE CONTROL/HEATED MEDIUM FLAT GLASS MANUAL/HEATED FULL CONVEX (MIRROR TO SWITCH CONNECTION)..... pg 10

REMOTE CONTROL/HEATED FULL FLAT GLASS REMOTE CONTROL/HEATED AUXILIARY CONVEX..... pg 11

REMOTE CONTROL/HEATED MEDIUM FLAT GLASS REMOTE CONTROL/HEATED FULL CONVEX..... pg 12

REMOTE CONTROL/HEATED MEDIUM GLASS (INVERTED) MANUAL/HEATED FULL CONVEX (INVERTED) MANUAL/HEATED AUXILIARY CONVEX (INVERTED)..... pg 13

V-MAX REMOTE CONTROL/HEATED FULL FLAT GLASS MANUAL/HEATED FULL CONVEX..... pg 14

REMOTE CONTROL/HEATED MEDIUM FLAT GLASS REMOTE CONTROL/HEATED FULL CONVEX REMOTE CONTROL/HEATED AUXILIARY CONVEX..... pg 15

REMOTE CONTROL/HEATED FULL FLAT GLASS W/TURN SIGNAL REMOTE CONTROL/HEATED AUXILIARY CONVEX..... pg 16

REMOTE CONTROL/HEATED MEDIUM FLAT GLASS W/TURN SIGNAL REMOTE CONTROL/HEATED FULL CONVEX GLASS REMOTE CONTROL/HEATED AUXILIARY CONVEX..... pg 17

GENERAL MIRROR SPECIFICATIONS

V-MAX MIRROR HEAD

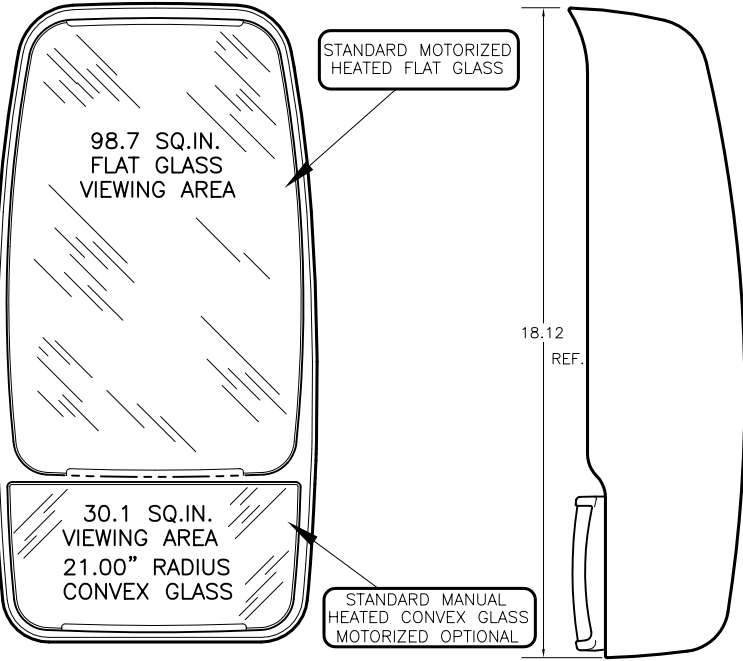

CLASS "A" HEAD W/ FULL FLAT GLASS AND OPTIONAL AUXILIARY CONVEX GLASS

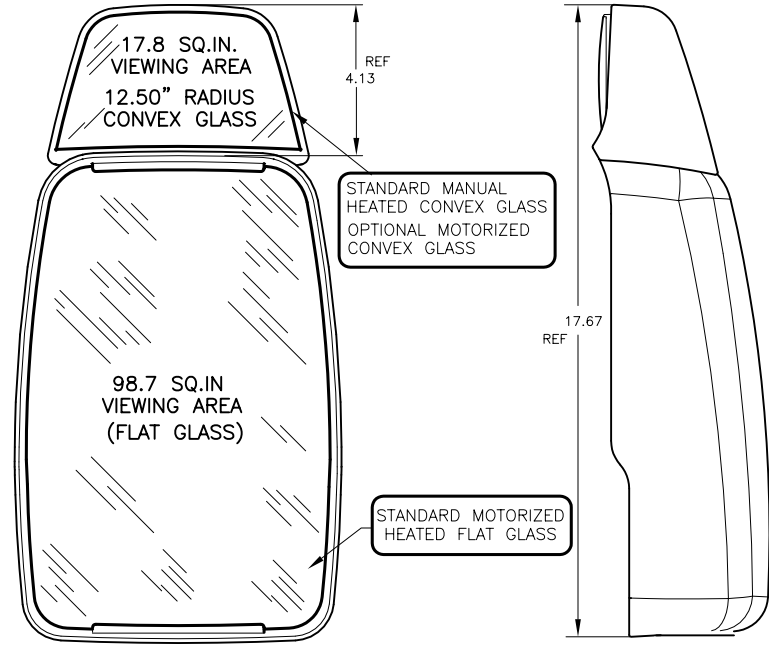

GLASS REPLACEMENT KIT NUMBERS

ALL MIRROR GLASS IS REPLACEABLE
INCLUDES HEATING ELEMENT
ORDER THE FOLLOWING KIT NUMBERS
INSTRUCTIONS INCLUDED

MEDIUM FLAT GLASS.....NO. 709448
FULL CONVEX GLASS.....NO. 709449
FULL FLAT GLASS.....NO. 709450
AUXILIARY CONVEX GLASS.....NO. 709451

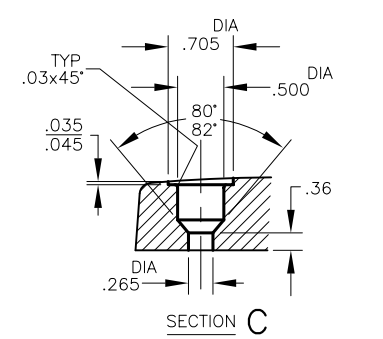

MIRROR HEAD ROTATION SET SCREW (ROUGH ADJUSTMENT)

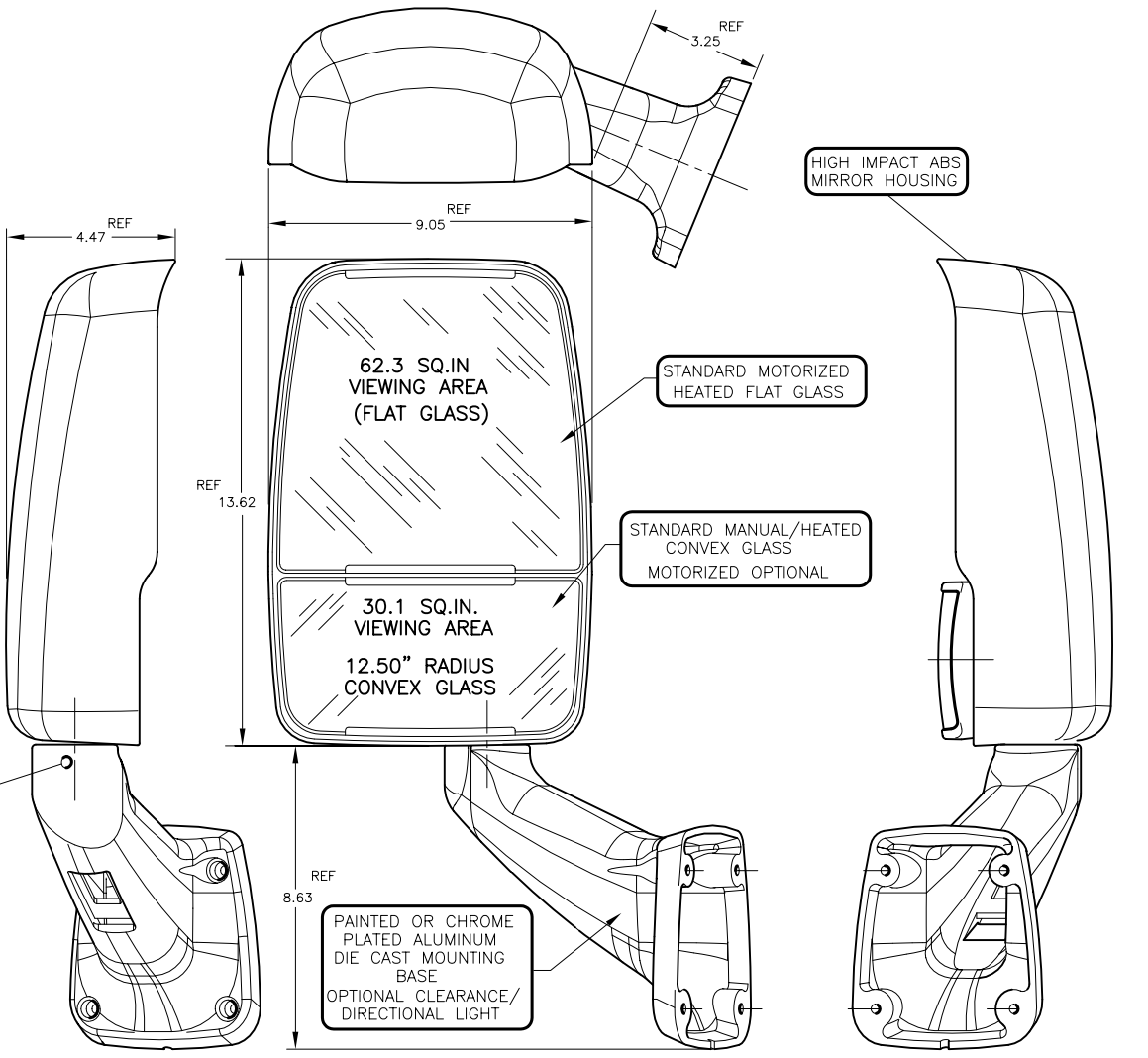
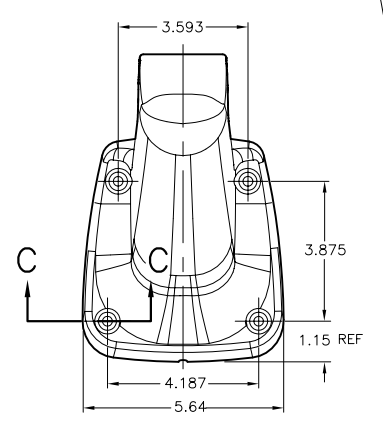

2025 BASE W/ CLASS "A" HEAD, MEDIUM FLAT GLASS AND FULL CONVEX GLASS

MOUNTING INSTRUCTIONS FOR 2025 MIRROR (HEATED & REMOTE CONTROL)

**** READ ALL INSTRUCTIONS FIRST BEFORE INSTALLING MIRROR ASSEMBLY ****

NOTE: INSTRUCTIONS ARE TYPICAL FOR BOTH LEFT AND RIGHT SIDES.

- 1) ROTATE MIRROR HEAD TO APPROXIMATE VIEWING POSITION BY LOOSENING ADJUSTMENT SCREW ON BASE WITH HEX WRENCH PROVIDED. LOOSEN ONLY ENOUGH TO ROTATE HEAD.
- 2) LOCATE MIRROR ASSEMBLY BELOW SIDE WINDOW AND AS FAR FORWARD AS POSSIBLE WHILE CHECKING FOR PROPER VISION FROM DRIVER'S SEAT. BE SURE THAT MOUNTING LOCATION WILL SUPPORT MIRROR. INNER FRAME SUPPORTS OR REINFORCED AREA IS RECOMMENDED. NOTE: CHECK INTERIOR WALL TO BE SURE MOUNTING LOCATION IS SUITABLE FOR THRU HOLE (1-5/16" DIA.) FOR ELECTRICAL WIRES.
- 3) MARK MOUNTING HOLE LOCATION BY MEASURING OR USING BASE AS TEMPLATE.
- 4) USING 1/4" MINIMUM SIZE SCREWS (NOT INCLUDED), DRILL APPROPRIATE SIZE SCREW HOLES.
- 5) LOCATE AND DRILL A 1-5/16" (MIN) HOLE FOR WIRE CABLE IN THE MIDDLE OF MOUNTING AREA. (BE SURE THEY'RE ARE NO SHARP EDGES)

6) FEED WIRE HARNESS THRU HOLE AND MOUNT MIRROR TO SIDE OF VEHICLE, LEAVING SLACK IN WIRE HARNESS INSIDE OF THE MIRROR BASE.

7) SOME MIRROR ASSEMBLY KITS INCLUDE INTERNAL WIRE HARNESS, REMOTE CONTROL SWITCH AND HEATER SWITCH AS SHOWN. IF INCLUDED REFER TO INDIVIDUAL INSTRUCTION SHEETS PROVIDED WITH KITS FOR PROPER WIRE INSTALLATION. IF NOT INCLUDED ORDER THE FOLLOWING VELVAC KITS TO COMPLETE THE WIRING INSTALLATION OR REFER TO INDEX PAGE FOR PROPER WIRING DIAGRAM FOR YOUR MIRROR.

WIRE HARNESS (RH-11 FT.).....PART NO. 747328

WIRE HARNESS (LH-5.5 FT.).....PART NO. 747329

REMOTE CONTROL SWITCH AND

HEATER CONTROL SWITCH KIT..... PART NO. 747198

NOTE: OTHER HARNESS AND CONTROL KITS ARE AVAILABLE.

MIRROR HEAD ADJUSTMENT

WITH DRIVER IN DRIVER'S SEAT ROTATE MIRROR HEAD TO APPROX. VIEWING POSITION AND TIGHTEN ADJUSTMENT SCREW IN BASE WITH HEX WRENCH PROVIDED.

(75-100 IN/LBS)

FOR FINE ADJUSTMENT OF MIRROR GLASS USE REMOTE CONTROL SWITCH.

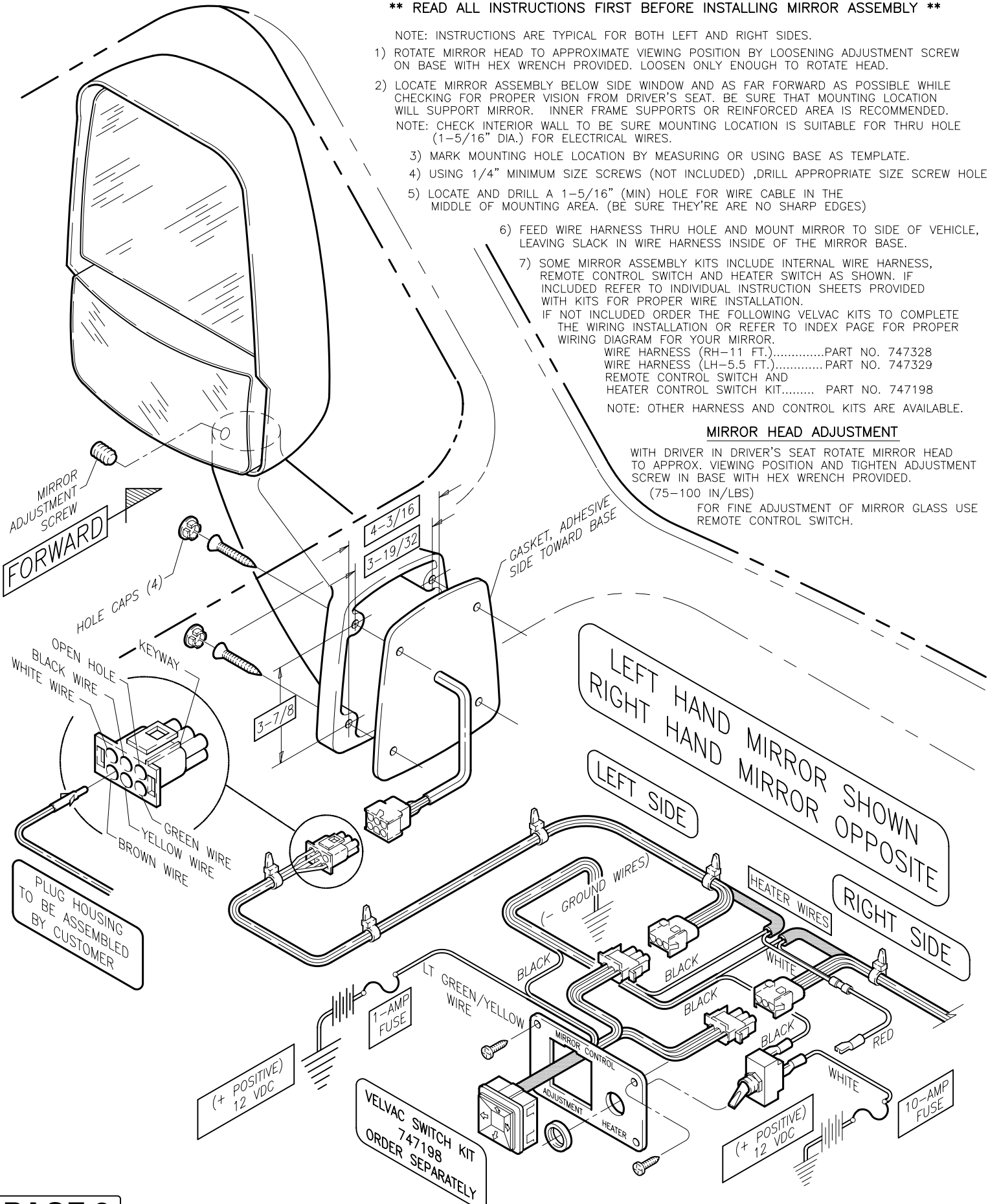

MOUNTING INSTRUCTIONS FOR 2025 MIRROR (HEATED & REMOTE CONTROL)

**** READ ALL INSTRUCTIONS FIRST BEFORE INSTALLING MIRROR ASSEMBLY ****

NOTE: INSTRUCTIONS ARE TYPICAL FOR BOTH LEFT AND RIGHT SIDES.

- 1) ROTATE MIRROR HEAD TO APPROXIMATE VIEWING POSITION BY LOOSENING ADJUSTMENT SCREW ON BASE WITH HEX WRENCH PROVIDED. LOOSEN ONLY ENOUGH TO ROTATE HEAD.
- 2) LOCATE MIRROR ASSEMBLY BELOW SIDE WINDOW AND AS FAR FORWARD AS POSSIBLE WHILE CHECKING FOR PROPER VISION FROM DRIVER'S SEAT. BE SURE THAT MOUNTING LOCATION WILL SUPPORT MIRROR. INNER FRAME SUPPORTS OR REINFORCED AREA IS RECOMMENDED.

NOTE: CHECK INTERIOR WALL TO BE SURE MOUNTING LOCATION IS SUITABLE FOR THRU HOLE (1-1/4" DIA.) FOR ELECTRICAL WIRES.

- 3) MARK MOUNTING HOLE LOCATION BY MEASURING OR USING BASE AS TEMPLATE.
- 4) USING 1/4" MINIMUM SIZE SCREWS (NOT INCLUDED), DRILL APPROPRIATE SIZE SCREW HOLES.
- 5) LOCATE AND DRILL A 1-1/4" (MIN) HOLE FOR WIRE CABLE IN THE MIDDLE OF MOUNTING AREA. (BE SURE THERE ARE NO SHARP EDGES)

- 6) FEED WIRE HARNESS THRU HOLE AND MOUNT MIRROR TO SIDE OF VEHICLE, LEAVING SLACK IN WIRE HARNESS INSIDE OF THE MIRROR BASE.
- 7) SOME MIRROR ASSEMBLY KITS INCLUDE REMOTE CONTROL SWITCH AND HEATER SWITCH AS SHOWN. IF INCLUDED REFER TO INSTRUCTION SHEET PROVIDED WITH KIT FOR PROPER WIRE INSTALLATION.

IF NOT INCLUDED ORDER THE FOLLOWING VELVAC KIT TO COMPLETE THE WIRING INSTALLATION OR REFER TO INDEX PAGE FOR PROPER WIRING DIAGRAM FOR YOUR MIRROR.

REMOTE CONTROL SWITCH AND HEATER CONTROL SWITCH KIT..... PART NO. 747198

NOTE: OTHER HARNESS AND CONTROL KITS ARE AVAILABLE.

MIRROR HEAD ADJUSTMENT

WITH DRIVER IN DRIVER'S SEAT ROTATE MIRROR HEAD TO APPROX. VIEWING POSITION AND TIGHTEN ADJUSTMENT SCREW IN BASE WITH HEX WRENCH PROVIDED. (75-100 IN/LBS)

FOR FINE ADJUSTMENT OF MIRROR GLASS USE REMOTE CONTROL SWITCH.

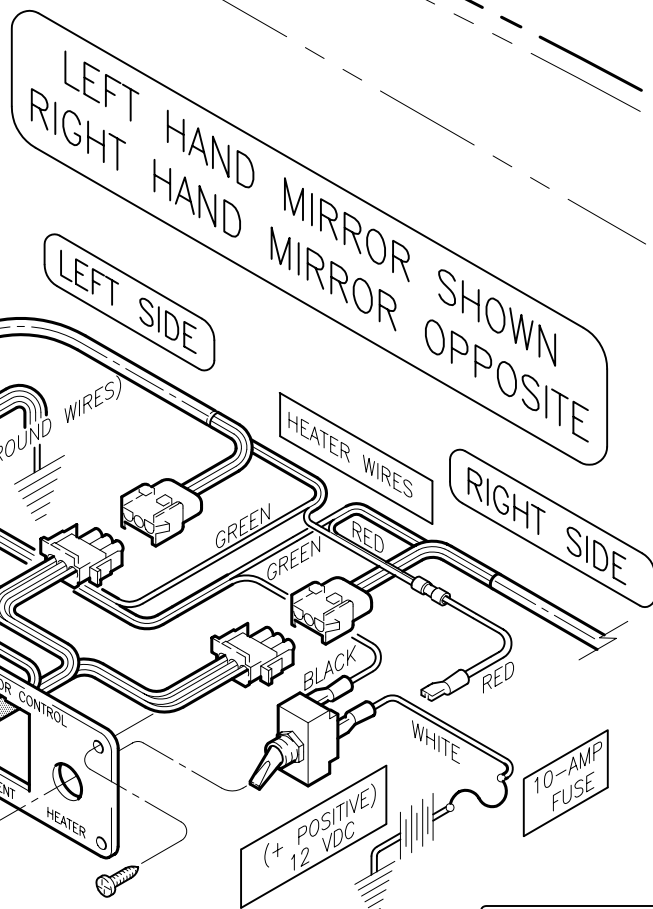
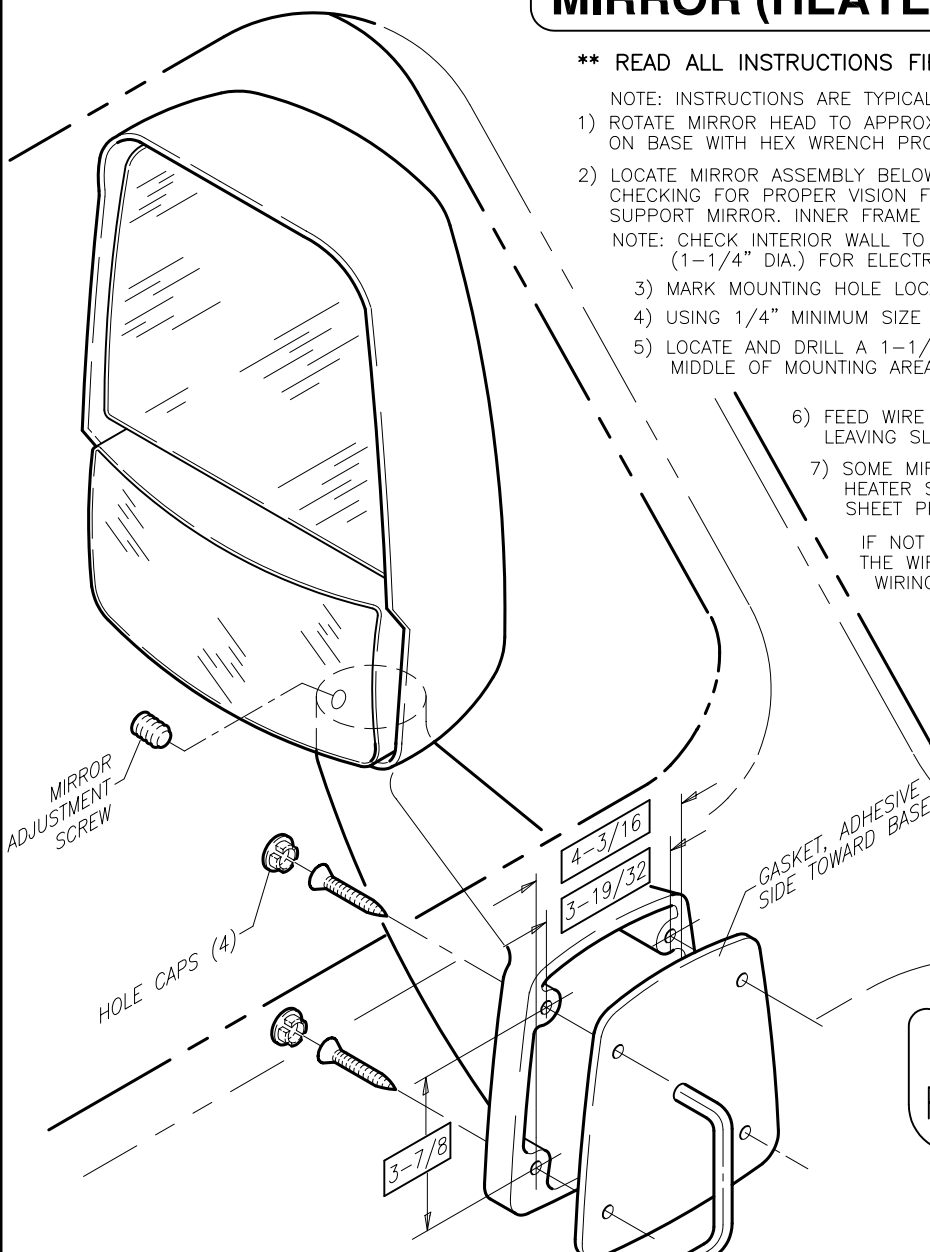

MOUNTING INSTRUCTIONS FOR 2030 BUS MIRROR (HEATED & REMOTE CONTROL)

**** READ ALL INSTRUCTIONS FIRST BEFORE INSTALLING MIRROR ASSEMBLY ****

NOTE: INSTRUCTIONS ARE TYPICAL FOR BOTH LEFT AND RIGHT SIDES.

MIRROR HEAD IS TURNED INWARD FOR SHIPMENT. LOOSEN SET SCREWS WITH HEX WRENCH PROVIDED AND ROTATE MIRROR HEAD AND PIVOT ARM TO APPROXIMATE POSITION FOR VIEWING. RETIGHTEN SET SCREWS.

- 1) WITH DRIVER IN DRIVER'S SEAT AND VIEWING THRU WINDSHIELD LOCATE MIRROR ASSEMBLY AS FAR FORWARD AS POSSIBLE WHILE CHECKING FOR PROPER VISION. BE SURE THE MOUNTING LOCATION WILL SUPPORT MIRROR ASSEMBLY. INNER FRAME SUPPORT OR REINFORCED AREA IS RECOMMENDED.
- 2) AFTER PROPER LOCATION FOR MIRROR ASSEMBLY HAS BEEN ESTABLISHED, MARK MOUNTING HOLE LOCATION BY USING MOUNTING BASE AS TEMPLATE BEING SURE THAT SIDES OF BASE ARE VERTICAL.
- 3) TAKE MOUNTING BASE GASKET (INCLUDED) AND PLACE ON MOUNTING HOLES PREVIOUSLY MARKED AND LOCATE CENTER OF LARGE HOLE AND MARK. DRILL A 1-1/4" (MIN) HOLE FOR WIRE CABLE BEING SURE THERE ARE NO SHARP EDGES.
- 4) USING 5/16" FLAT HEAD SCREWS OR BOLTS (1/4" MINIMUM) (NOT INCLUDED) DRILL APPROPRIATE SIZE SCREW HOLES.
- 5) FEED WIRE HARNESS THRU HOLE, MOUNT BASE GASKET AND MIRROR ASSEMBLY TO VEHICLE, LEAVING SLACK IN WIRE HARNESS INSIDE OF THE MIRROR ARM. SNAP BASE CAPS (4) PROVIDED INTO MOUNTING HOLES IN BASE.

NOTE: SOME MIRROR ASSEMBLY KITS INCLUDE INTERNAL WIRE HARNESS, REMOTE CONTROL SWITCH AND HEATER SWITCH AS SHOWN. IF INCLUDED REFER TO INDIVIDUAL INSTRUCTION SHEETS PROVIDED WITH KITS FOR PROPER WIRE INSTALLATION. IF NOT INCLUDED, ORDER THE FOLLOWING VELVAC KITS TO COMPLETE THE WIRING INSTALLATION OR REFER TO INDEX PAGE FOR PROPER WIRING DIAGRAM FOR YOUR MIRROR.

WIRE HARNESS (RH-11 FT.).....	PART NO. 747328
WIRE HARNESS (LH-5.5 FT.).....	PART NO. 747329
REMOTE CONTROL SWITCH AND HEATER CONTROL SWITCH.....	PART NO. 747198

NOTE: OTHER HARNESS AND CONTROL KITS ARE AVAILABLE.

MIRROR HEAD ADJUSTMENT

LOOSEN SET SCREWS (3) AS SHOWN AT MIRROR HEAD PIVOT AND AT PIVOT ARM BASE. WITH DRIVER IN DRIVER'S SEAT ROTATE MIRROR HEAD AND PIVOT ARM TO APPROXIMATE VIEWING POSITION. TIGHTEN MIRROR HEAD PIVOT (1) TO APPROX. 75 IN/LBS AND PIVOT ARM BASE (2) TO 100/125 IN/LBS. PLUG ALL SCREW HOLES (3) AS SHOWN WITH CAPS PROVIDED. FOR FINE ADJUSTMENT OF MIRROR GLASS USE REMOTE CONTROL SWITCH ON DASHBOARD.

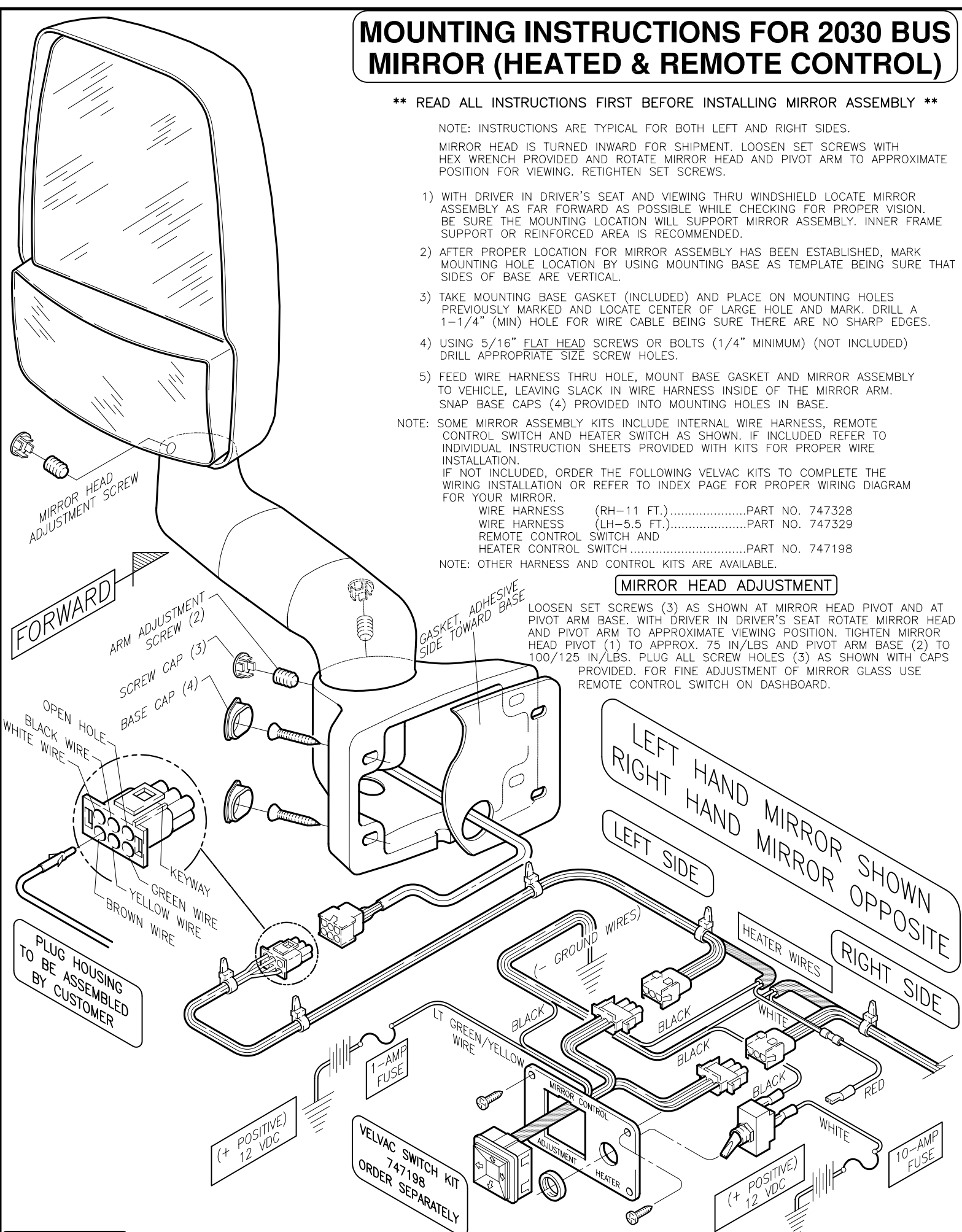

MOUNTING INSTRUCTIONS FOR "REVOLUTION" MIRROR ASSEMBLY

READ ALL INSTRUCTIONS FIRST BEFORE INSTALLING MIRROR ASSEMBLY

NOTE: INSTRUCTIONS ARE TYPICAL FOR BOTH LEFT AND RIGHT SIDES.

- 1) ROTATE MIRROR HEAD TO APPROXIMATE VIEWING POSITION BY LOOSENING ADJUSTMENT SCREW (#1) ON ARM WITH HEX WRENCH PROVIDED. LOOSEN ONLY ENOUGH TO ROTATE MIRROR HEAD.
- 2) LOCATE MIRROR ASSEMBLY BELOW WINDOW AND AS FAR FORWARD AS POSSIBLE CHECKING FOR PROPER VISION FROM DRIVER'S SEAT. BE SURE THAT MOUNTING LOCATION WILL SUPPORT MIRROR. INNER FRAME SUPPORTS OR REINFORCED AREA IS RECOMMENDED. NOTE: CHECK INTERIOR WALL TO BE SURE MOUNTING LOCATION IS SUITABLE FOR (1-5/16") THRU HOLE FOR ELECTRICAL PLUG (#3).
- 3) MARK LOCATION FOR MOUNTING HOLES BY USING GASKET (#2) AS TEMPLATE OR REFER TO FULL SIZE GASKET PRINT ON PAGE 7 OF INSTRUCTION SHEET.
- 4) USING 1/4" MINIMUM SIZE SCREWS (NOT INCLUDED) DRILL APPROPRIATE SIZE SCREW HOLES. BE SURE TO USE ONLY FLAT OR PAN HEAD SCREWS.
- 5) DRILL 1-5/16" MINIMUM HOLE FOR WIRE CABLE (#3) AS SHOWN ON GASKET DRAWING ON BACK SIDE OF SHEET. BE SURE THERE ARE NO SHARP EDGES.
- 6) PEEL OFF ADHESIVE BACKING OF GASKET (#2) LINING UP WITH HOLES AND FIRMLY PRESS AGAINST SIDE WALL OF VEHICLE.
- 7) MOUNT BRACKET (#4) AGAINST GASKET (#2) BEING SURE MOUNTING HOLES ARE LINED UP AND BRACKET IS IN VERTICAL POSITION BEFORE TIGHTENING SCREWS.
- 8) WITH MIRROR ASSEMBLY IN HAND FEED WIRE HARNESS THRU SLOTTED HOLE IN GASKET. TO MOUNT BASE CASTING (#5) ON MOUNTING BRACKET (#4) TILT ASSEMBLY SLIGHTLY BEING SURE FLANGE OF BRACKET IS RESTING ON TOP OF RIBS INSIDE OF BASE. (SEE VIEW "A" BELOW) STRAIGHTEN MIRROR ASSEMBLY BACK TO VERTICAL POSITION AND SLIDE DOWN BASE ON TO BRACKET AS FAR AS POSSIBLE WITH SLIGHT PRESSURE.
- 9) INSERT MOUNTING SCREW (#6) INTO THRU HOLE AT BOTTOM OF BASE ROTATING SCREW UNTIL CONTACT IS MADE WITH THREADS INSIDE OF BASE. SHIFT ASSEMBLY BACK AND FORTH SLIGHTLY IF NECESSARY TO LINE UP WITH THREADED HOLE. TIGHTEN TO 60/70 IN-LBS.
- 10) WITH DRIVER'S IN DRIVER'S SEAT ROTATE MIRROR HEAD TO APPROX. VIEWING POSITION AND TIGHTEN SET SCREW (#1) IN BASE WITH HEX WRENCH PROVIDED TO 75/100 IN-LBS. FOR FINE ADJUSTMENT OF MIRROR GLASS USE REMOTE CONTROL SWITCH.

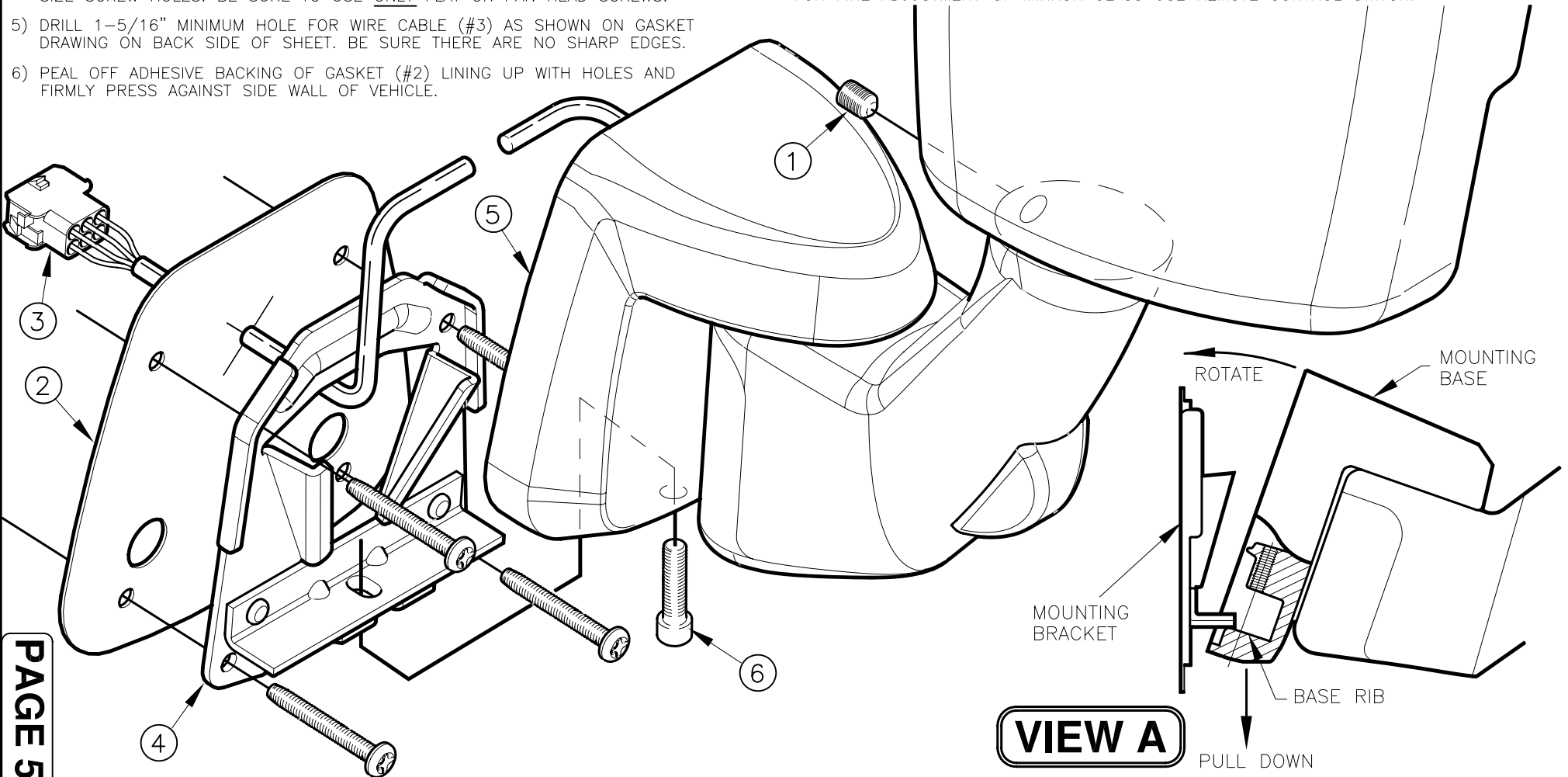

VIEW A

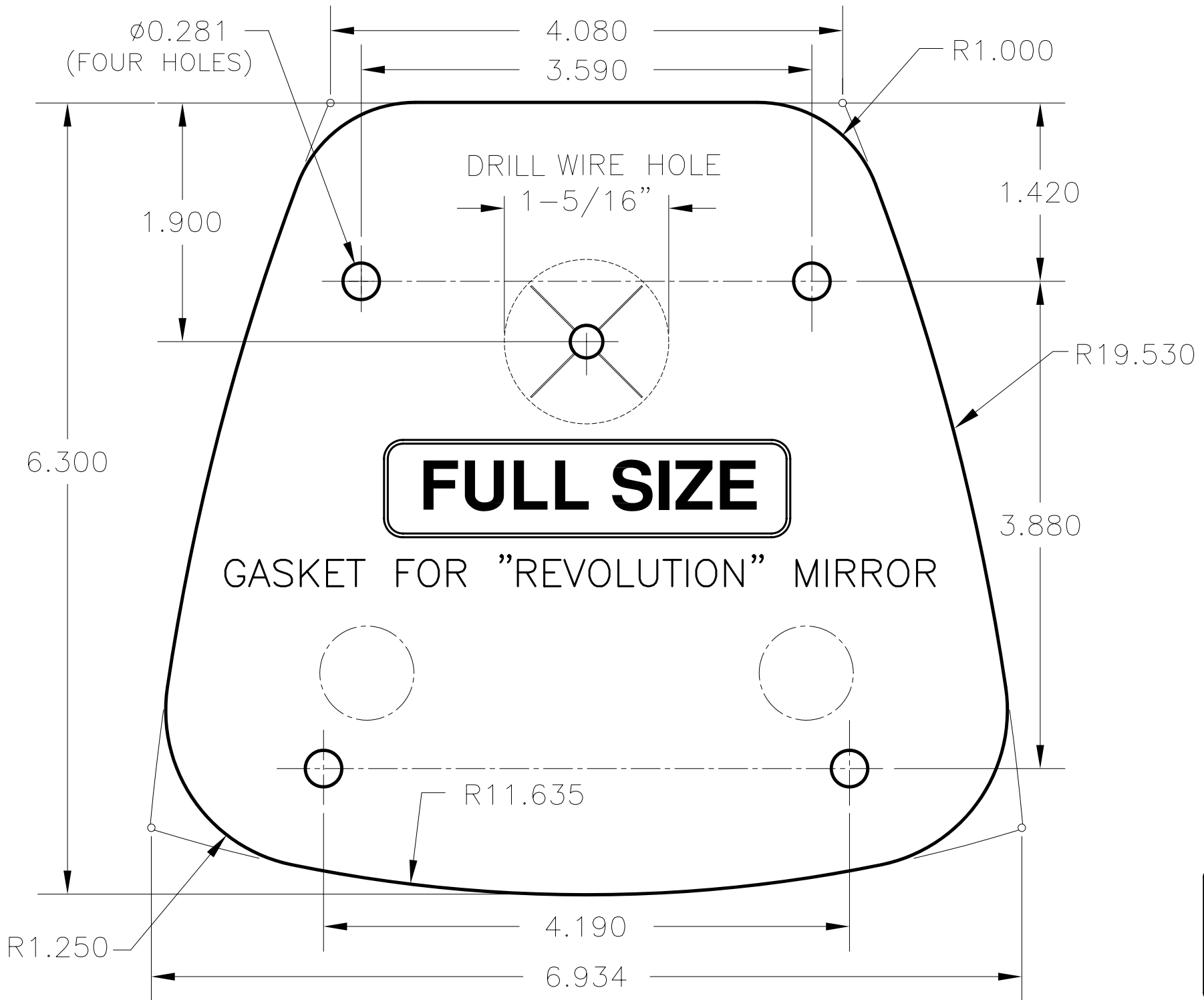

WIRING DIAGRAM FOR REMOTE CONTROL/HEATED GLASS AND MANUAL/HEATED CONVEX GLASS

LEFT HAND SIDE

RIGHT HAND SIDE

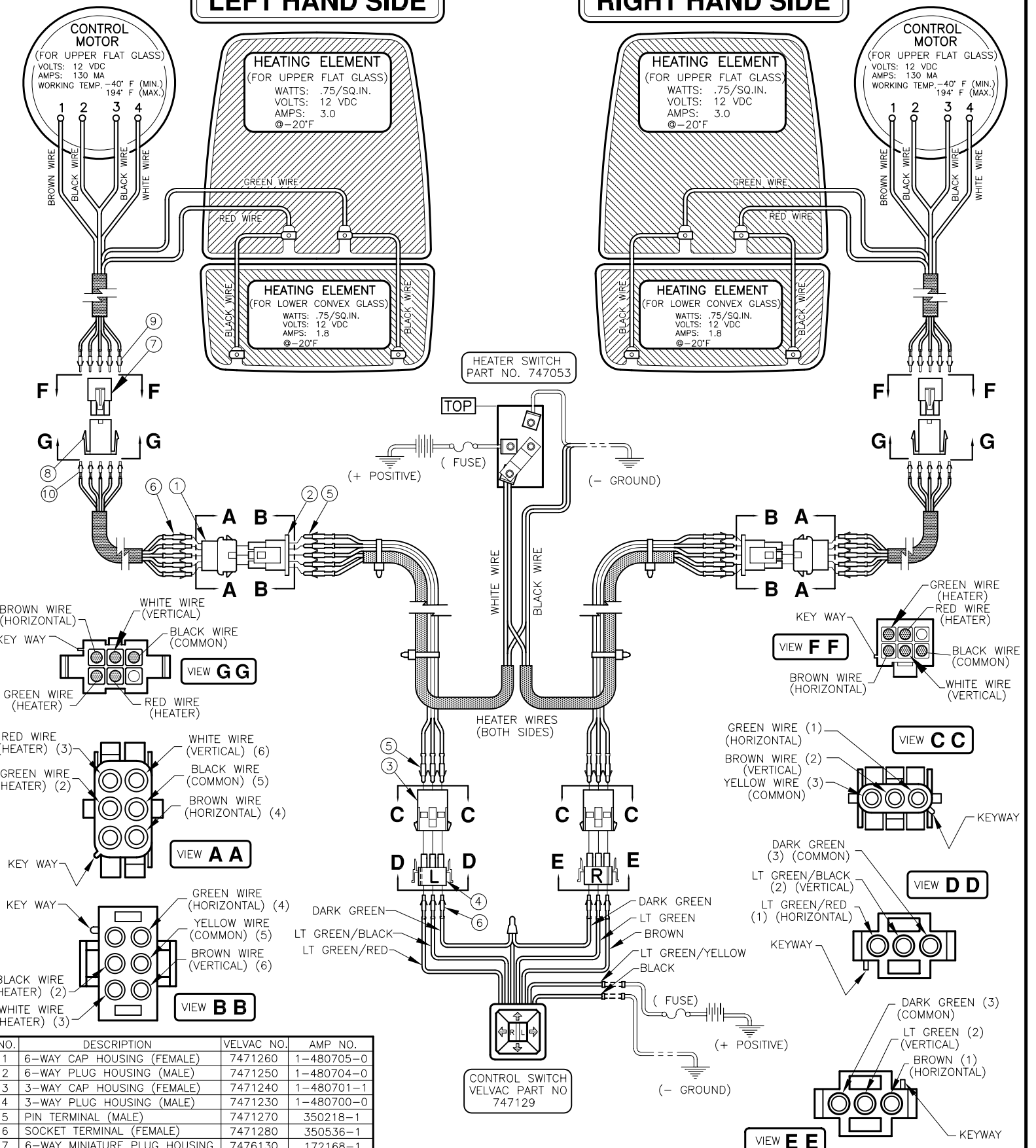

NO.	DESCRIPTION	VELVAC NO.	AMP NO.
1	6-WAY CAP HOUSING (FEMALE)	7471260	1-480705-0
2	6-WAY PLUG HOUSING (MALE)	7471250	1-480704-0
3	3-WAY CAP HOUSING (FEMALE)	7471240	1-480701-1
4	3-WAY PLUG HOUSING (MALE)	7471230	1-480700-0
5	PIN TERMINAL (MALE)	7471270	350218-1
6	SOCKET TERMINAL (FEMALE)	7471280	350536-1
7	6-WAY MINIATURE PLUG HOUSING	7476130	172168-1
8	6-WAY MINIATURE CAP HOUSING	7476120	172160-1
9	MINIATURE MALE PIN TERMINAL		770987-1
10	MINIATURE FEMALE PIN TERMINAL		770988-1

WIRING DIAGRAM FOR REMOTE CONTROL /HEATED GLASS, MANUAL/HEATED CONVEX

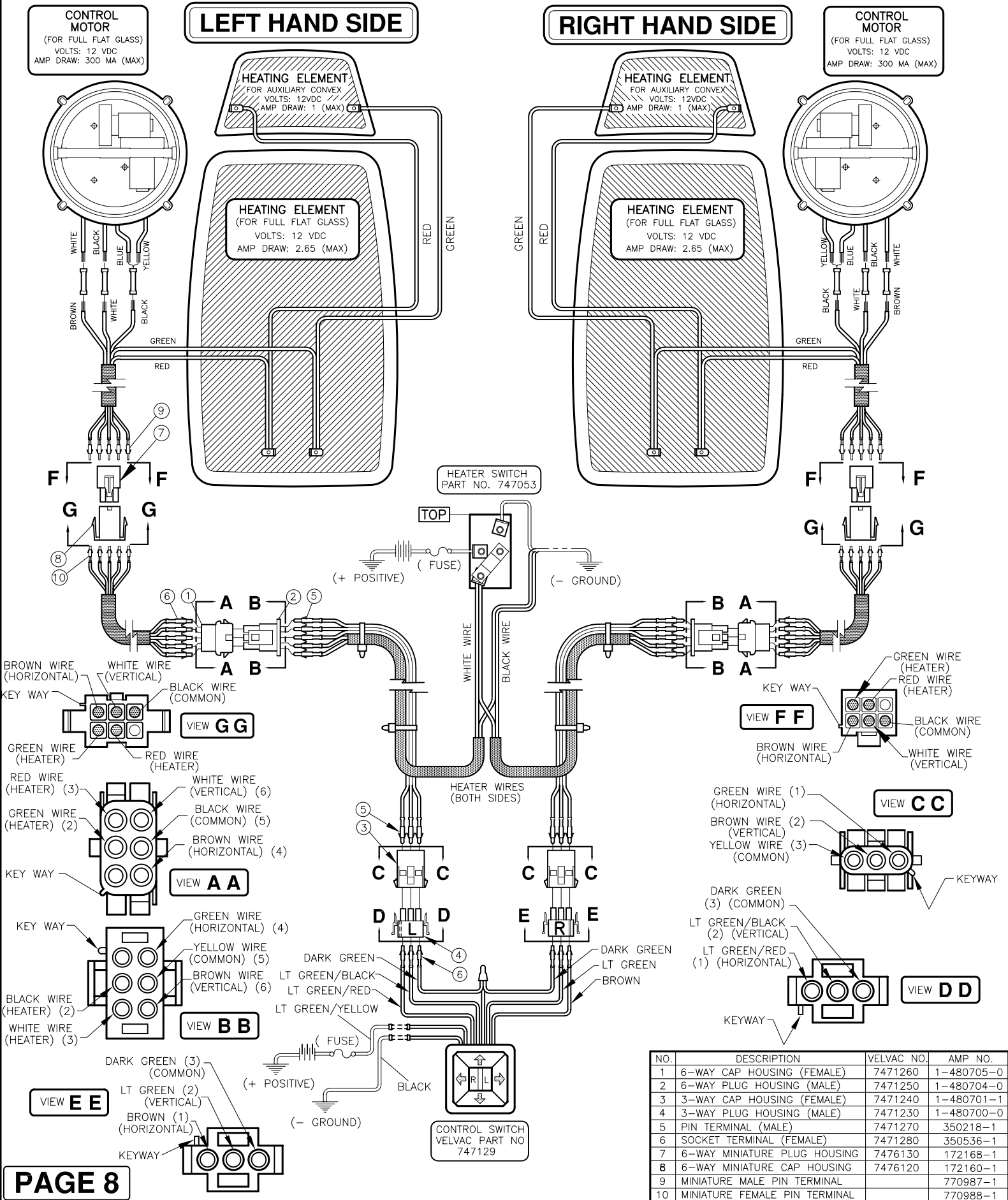

WIRING DIAGRAM FOR REMOTE CONTROL /HEATED GLASS AND MANUAL/HEATED CONVEX GLASS (INVERTED)

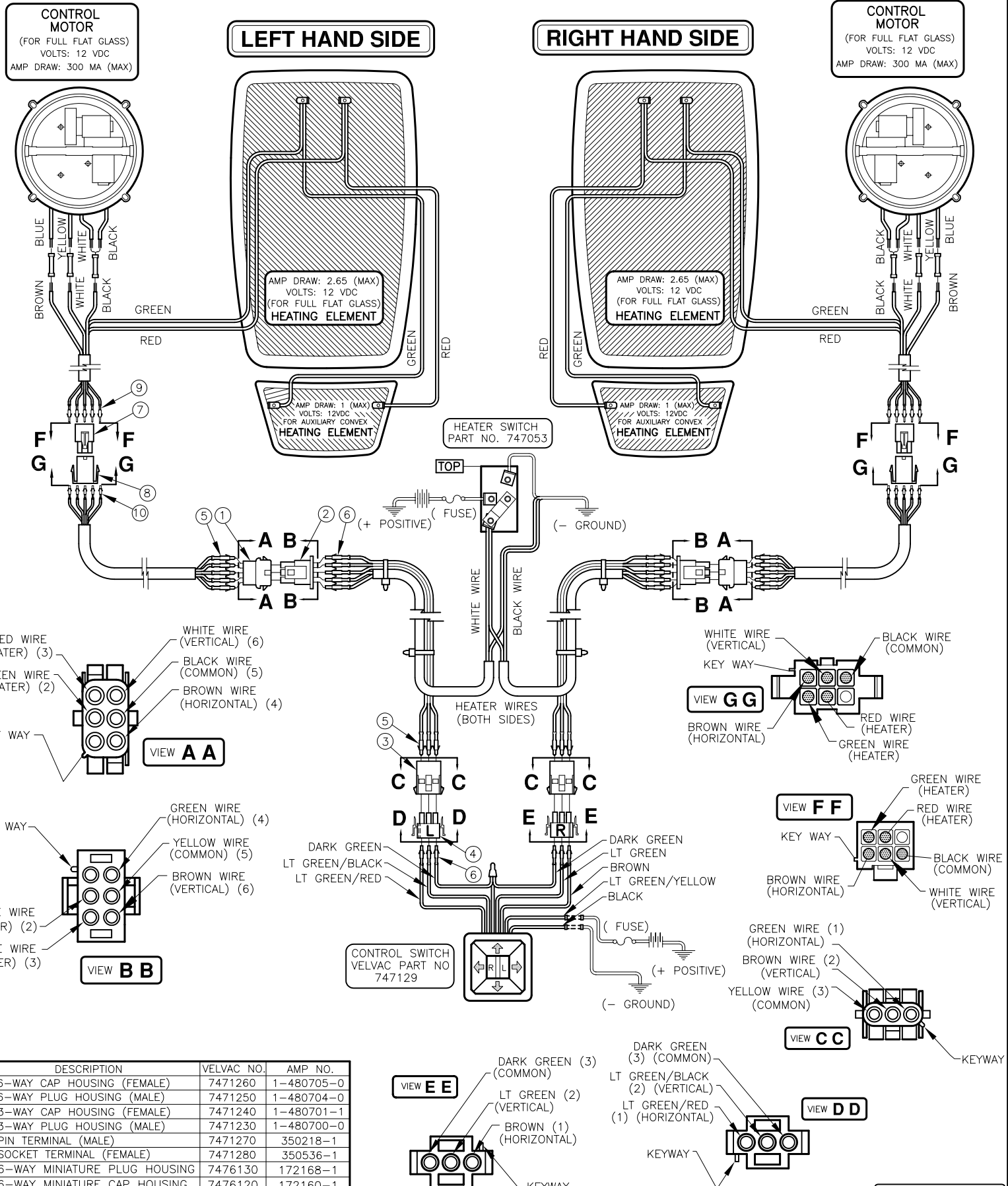

NO.	DESCRIPTION	VELVAC NO.	AMP NO.
1	6-WAY CAP HOUSING (FEMALE)	7471260	1-480705-0
2	6-WAY PLUG HOUSING (MALE)	7471250	1-480704-0
3	3-WAY CAP HOUSING (FEMALE)	7471240	1-480701-1
4	3-WAY PLUG HOUSING (MALE)	7471230	1-480700-0
5	PIN TERMINAL (MALE)	7471270	350218-1
6	SOCKET TERMINAL (FEMALE)	7471280	350536-1
7	6-WAY MINIATURE PLUG HOUSING	7476130	172168-1
8	6-WAY MINIATURE CAP HOUSING	7476120	172160-1
9	MINIATURE MALE PIN TERMINAL		770987-1
10	MINIATURE FEMALE PIN TERMINAL		770988-1

WIRING DIAGRAM FOR REMOTE CONTROL/HEATED GLASS AND MANUAL/HEATED CONVEX GLASS

LEFT HAND SIDE

RIGHT HAND SIDE

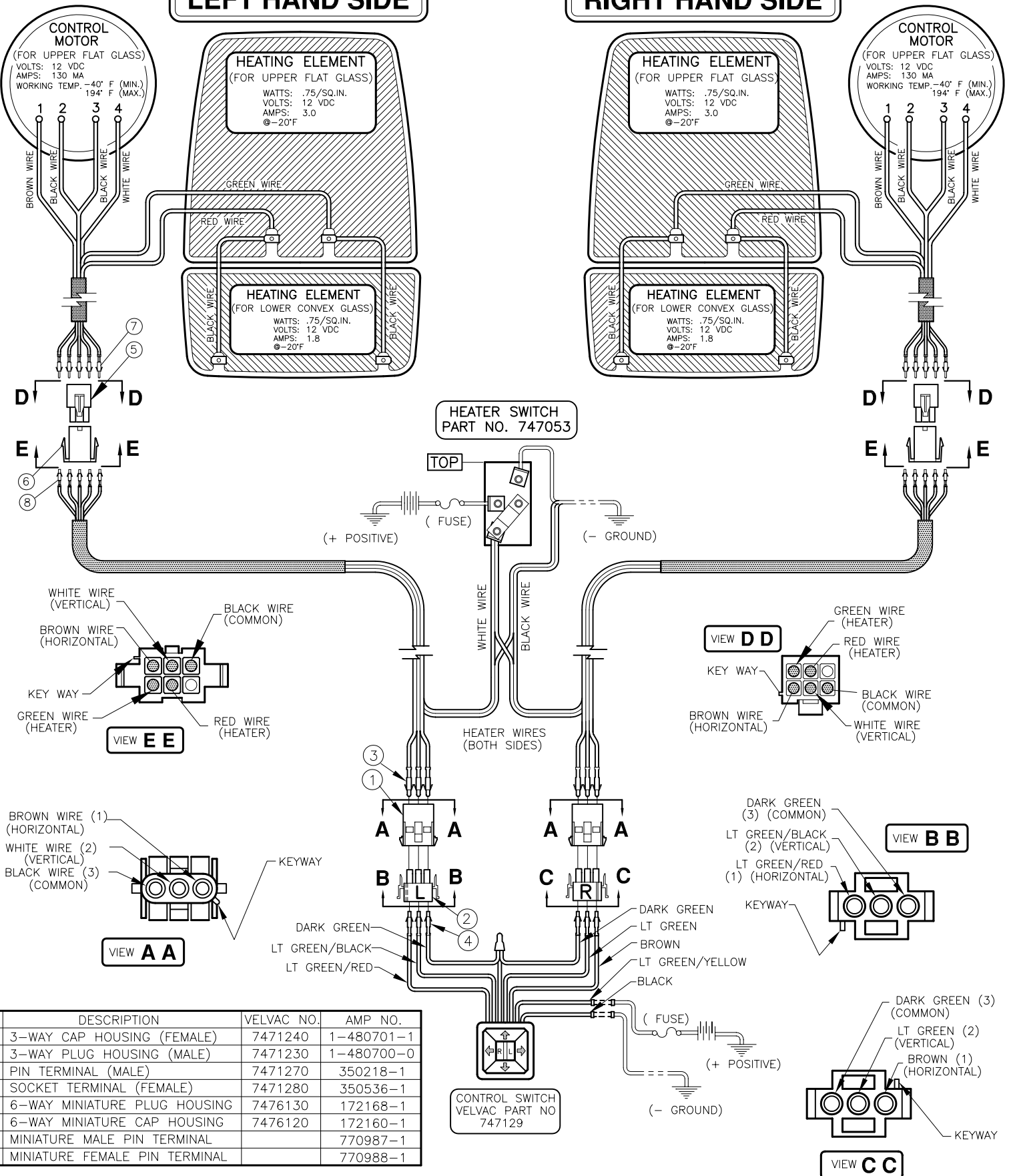

WIRING DIAGRAM FOR REMOTE CONTROL/HEATED FULL FLAT GLASS AND REMOTE/HEATED AUX. CONVEX GLASS

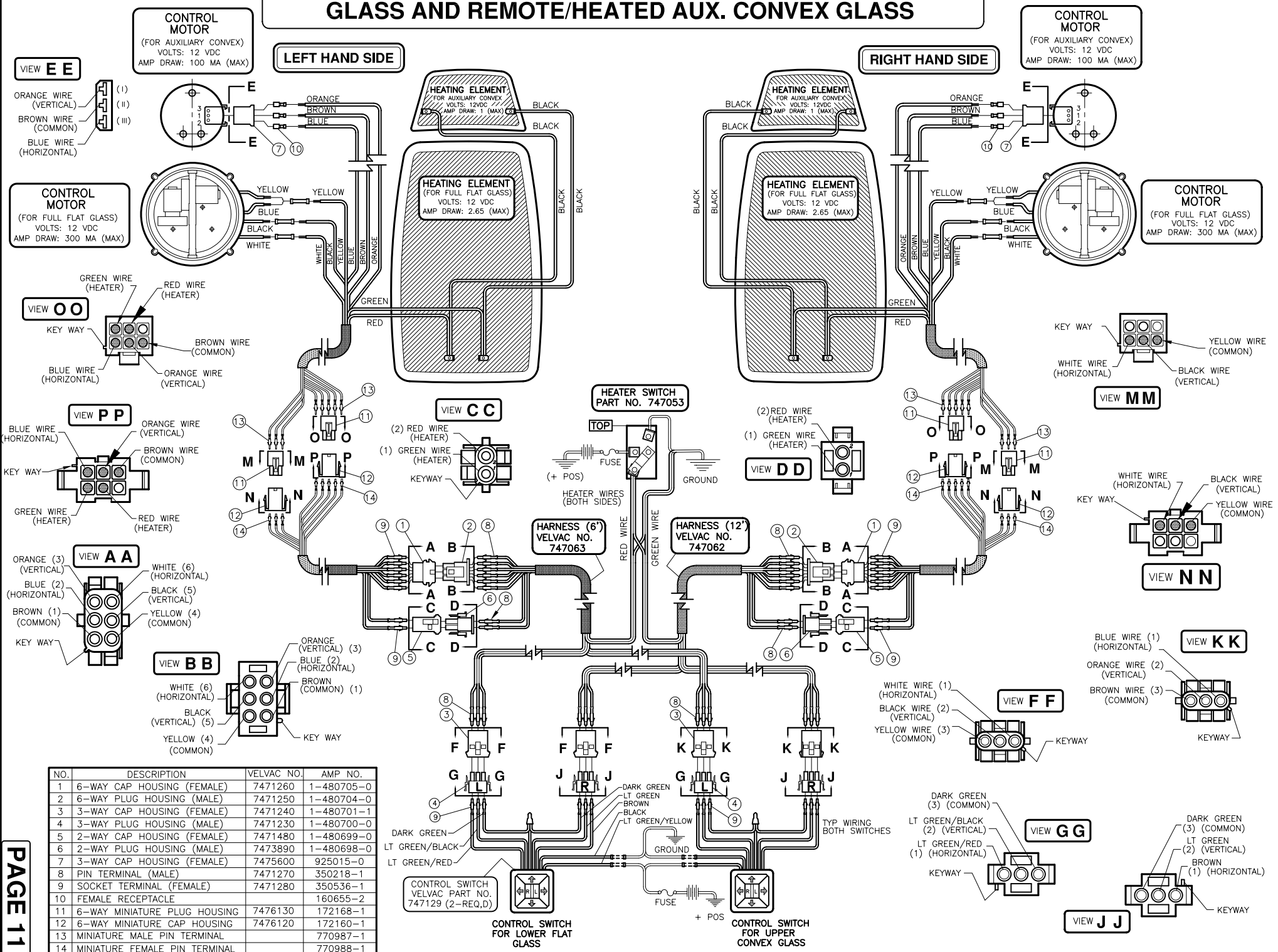

CONTROL MOTOR
(FOR AUXILIARY CONVEX)
VOLTS: 12 VDC
AMP DRAW: 100 MA (MAX)

CONTROL MOTOR
(FOR AUXILIARY CONVEX)
VOLTS: 12 VDC
AMP DRAW: 100 MA (MAX)

VIEW EE

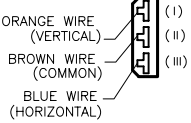

CONTROL MOTOR
(FOR FULL FLAT GLASS)
VOLTS: 12 VDC
AMP DRAW: 300 MA (MAX)

CONTROL MOTOR
(FOR FULL FLAT GLASS)
VOLTS: 12 VDC
AMP DRAW: 300 MA (MAX)

VIEW OO

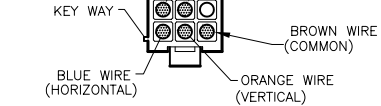

VIEW MM



VIEW PP

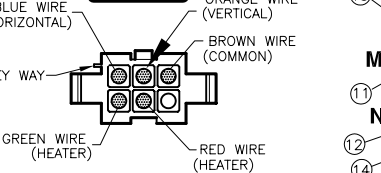

VIEW NN

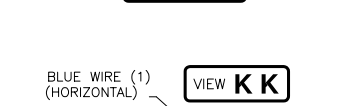

VIEW AA

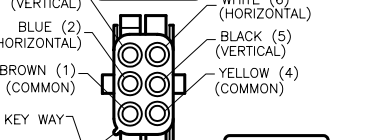

VIEW BB

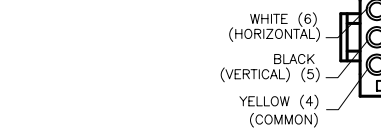

VIEW KK

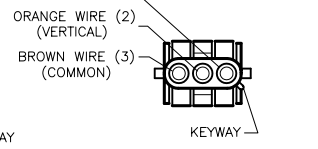

VIEW FF

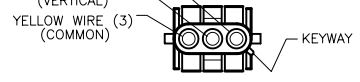

VIEW GG

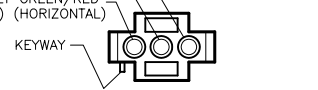

VIEW JJ



NO.	DESCRIPTION	VELVAC NO.	AMP NO.
1	6-WAY CAP HOUSING (FEMALE)	7471260	1-480705-0
2	6-WAY PLUG HOUSING (MALE)	7471250	1-480704-0
3	3-WAY CAP HOUSING (FEMALE)	7471240	1-480701-1
4	3-WAY PLUG HOUSING (MALE)	7471230	1-480700-0
5	2-WAY CAP HOUSING (FEMALE)	7471480	1-480699-0
6	2-WAY PLUG HOUSING (MALE)	7473890	1-480698-0
7	3-WAY CAP HOUSING (FEMALE)	7475600	925015-0
8	PIN TERMINAL (MALE)	7471270	350218-1
9	SOCKET TERMINAL (FEMALE)	7471280	350536-1
10	FEMALE RECEPTACLE		160655-2
11	6-WAY MINIATURE PLUG HOUSING	7476130	172168-1
12	6-WAY MINIATURE CAP HOUSING	7476120	172160-1
13	MINIATURE MALE PIN TERMINAL		770987-1
14	MINIATURE FEMALE PIN TERMINAL		770988-1

WIRING DIAGRAM FOR REMOTE CONTROL/HEATED FLAT GLASS AND REMOTE CONTROL/HEATED CONVEX GLASS

LEFT HAND SIDE

RIGHT HAND SIDE

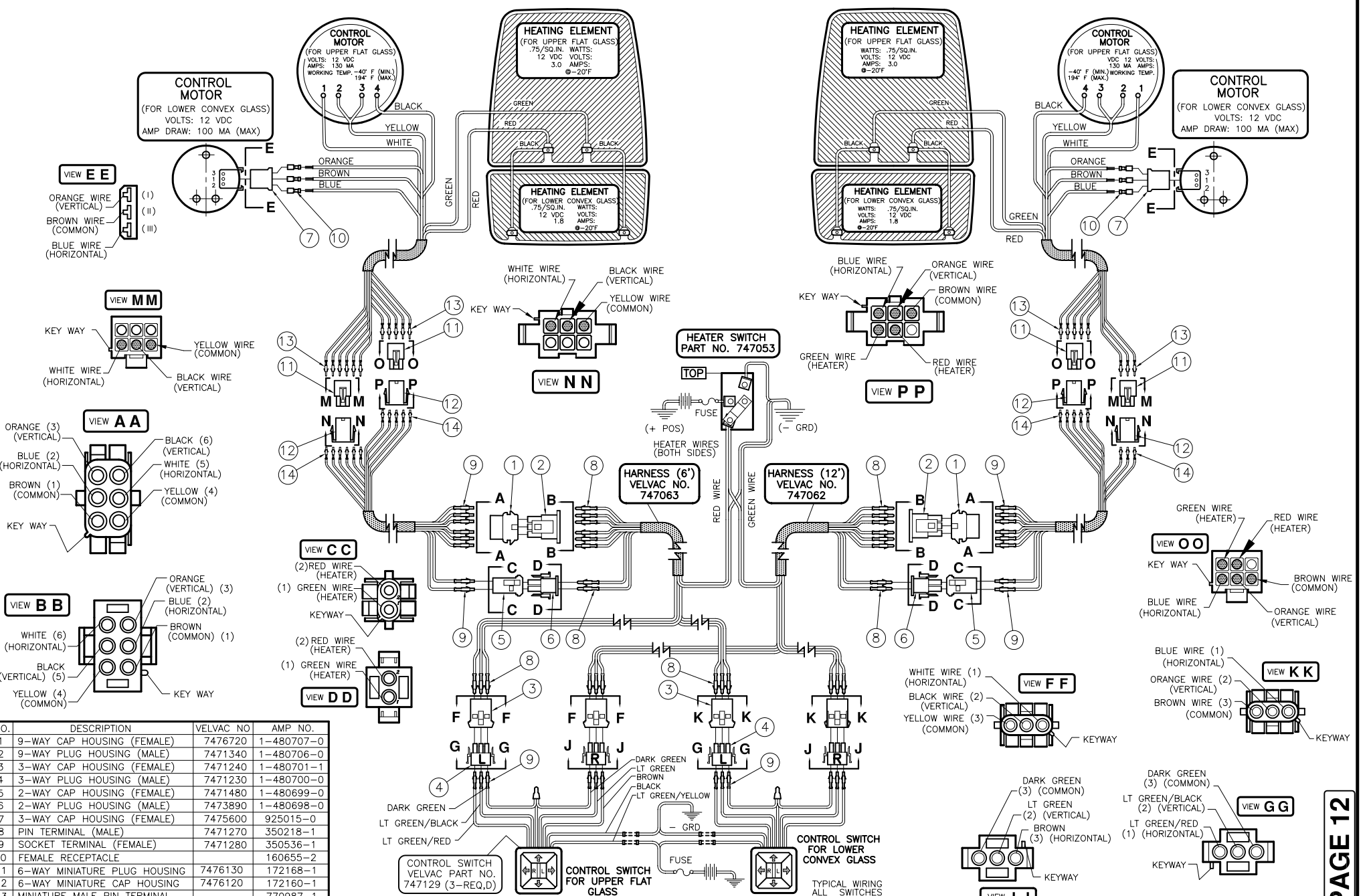

NO.	DESCRIPTION	VELVAC NO	AMP. NO.
1	9-WAY CAP HOUSING (FEMALE)	7476720	1-480707-0
2	9-WAY PLUG HOUSING (MALE)	7471340	1-480706-0
3	3-WAY CAP HOUSING (FEMALE)	7471240	1-480701-1
4	3-WAY PLUG HOUSING (MALE)	7471230	1-480700-0
5	2-WAY CAP HOUSING (FEMALE)	7471480	1-480699-0
6	2-WAY PLUG HOUSING (MALE)	7473890	1-480698-0
7	3-WAY CAP HOUSING (FEMALE)	7475600	925015-0
8	PIN TERMINAL (MALE)	7471270	350218-1
9	SOCKET TERMINAL (FEMALE)	7471280	350536-1
10	FEMALE RECEPTACLE		160655-2
11	6-WAY MINIATURE PLUG HOUSING	7476130	172168-1
12	6-WAY MINIATURE CAP HOUSING	7476120	172160-1
13	MINIATURE MALE PIN TERMINAL		770987-1
14	MINIATURE FEMALE PIN TERMINAL		770988-1

WIRING DIAGRAM FOR REMOTE CONTROL/HEATED FLAT GLASS , MANUAL/HEATED CONVEX AND MANUAL/HEATED AUXILIARY CONVEX (INVERTED)

LEFT HAND SIDE

RIGHT HAND SIDE

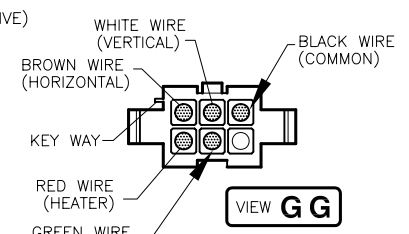
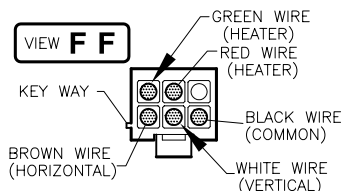
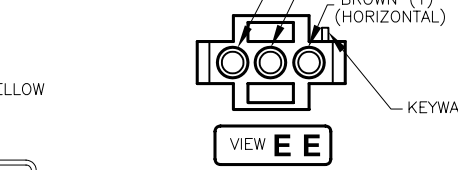
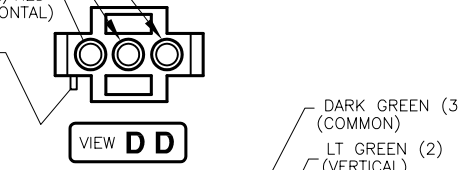
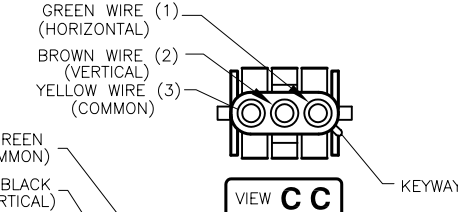
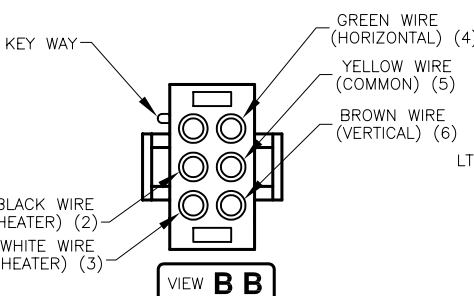
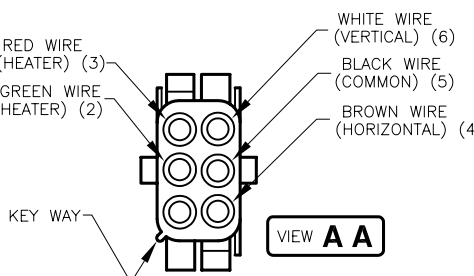
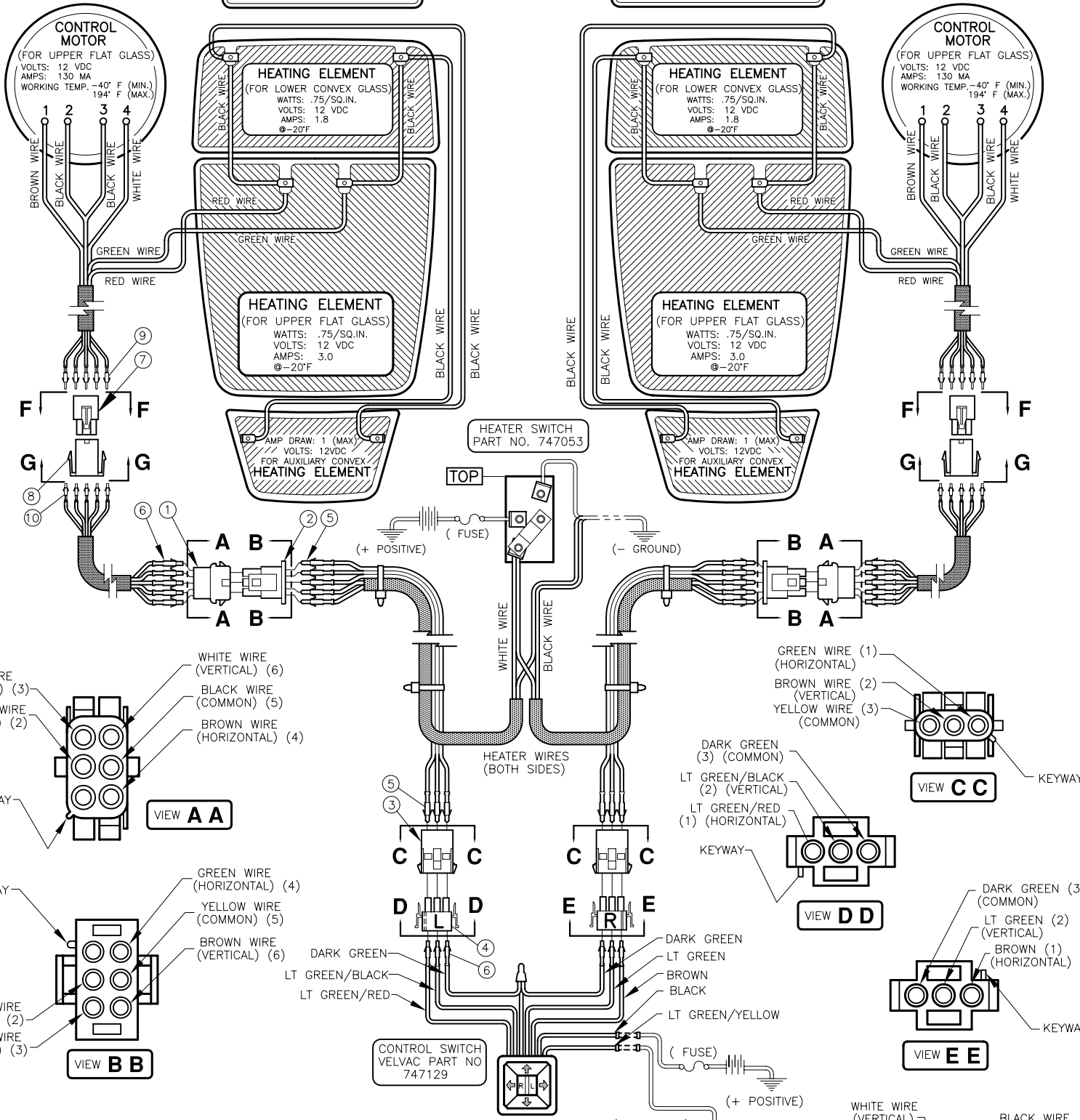

NO.	DESCRIPTION	VELVAC NO.	AMP NO.
1	6-WAY CAP HOUSING (FEMALE)	7471260	1-480705-0
2	6-WAY PLUG HOUSING (MALE)	7471250	1-480704-0
3	3-WAY CAP HOUSING (FEMALE)	7471240	1-480701-1
4	3-WAY PLUG HOUSING (MALE)	7471230	1-480700-0
5	PIN TERMINAL (MALE)	7471270	350218-1
6	SOCKET TERMINAL (FEMALE)	7471280	350536-1
7	6-WAY MINIATURE PLUG HOUSING	7476130	172168-1
8	6-WAY MINIATURE CAP HOUSING	7476120	172160-1
9	MINIATURE MALE PIN TERMINAL		770987-1
10	MINIATURE FEMALE PIN TERMINAL		770988-1

WIRING DIAGRAM FOR V-MAX REMOTE CONTROL, HEATED FULL FLAT GLASS AND HEATED ONLY FULL CONVEX GLASS

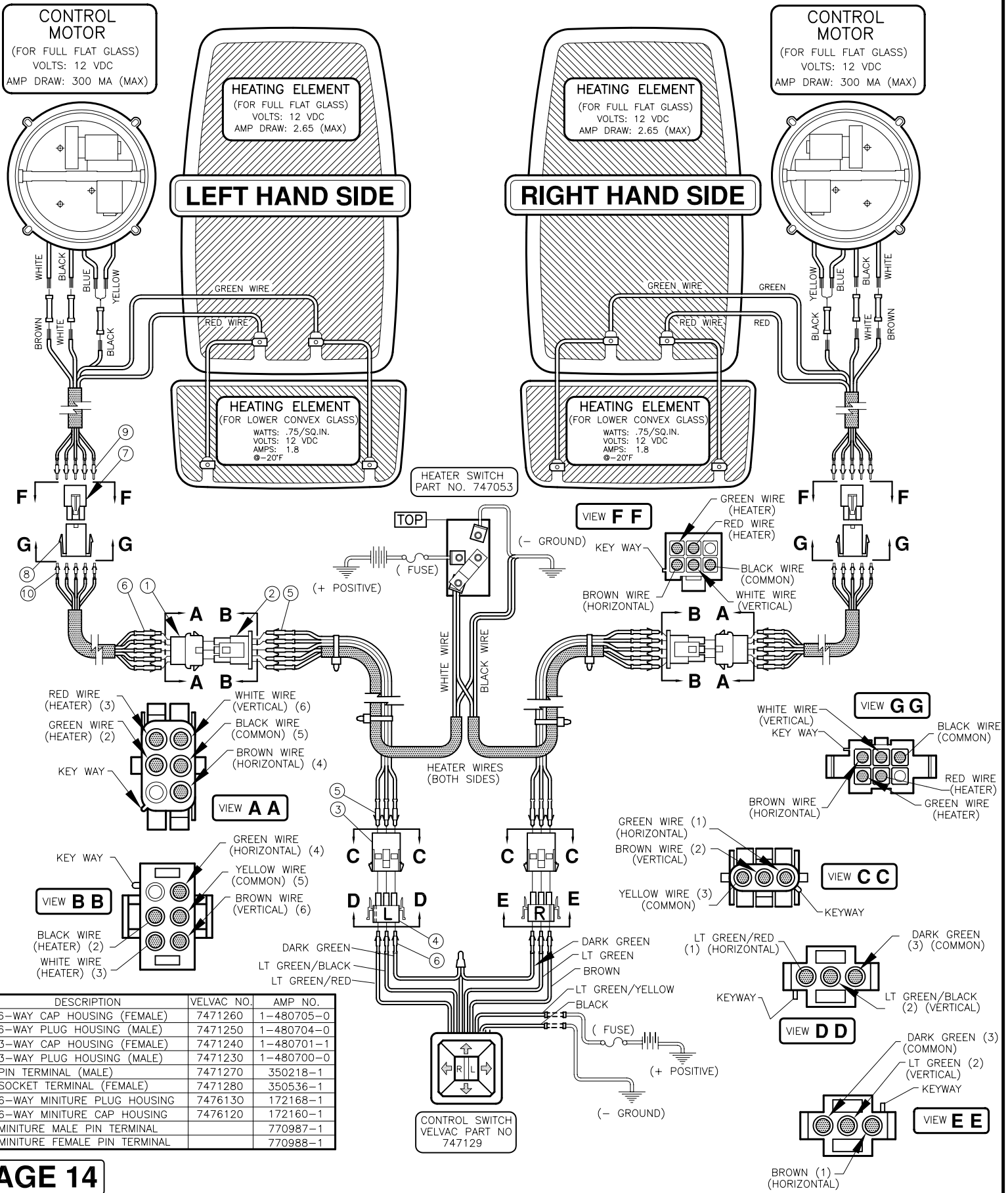

WIRING DIAGRAM FOR REMOTE CONTROL/HEATED FLAT GLASS AND REMOTE CONTROL/HEATED CONVEX GLASS

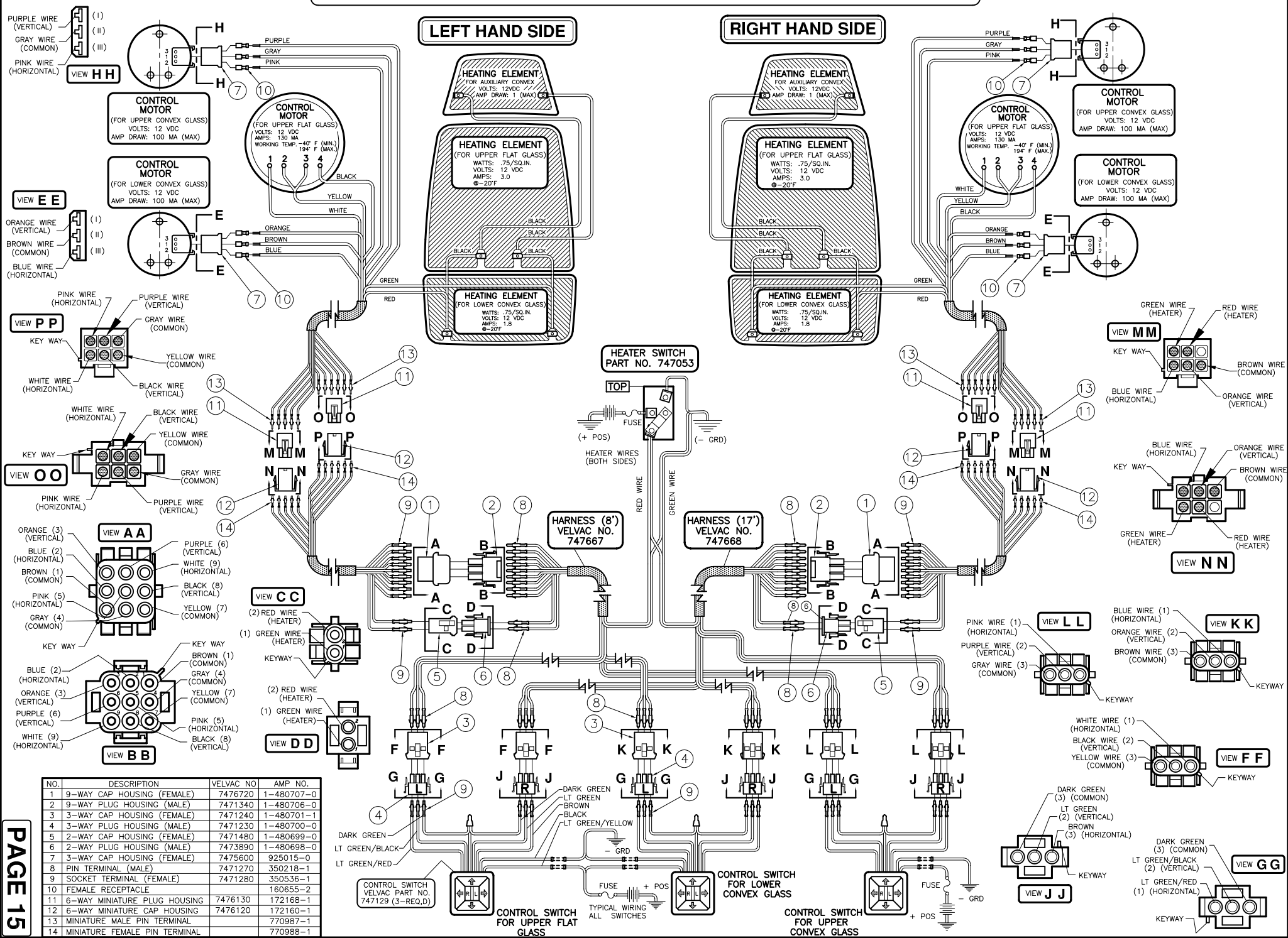

LEFT HAND SIDE

RIGHT HAND SIDE

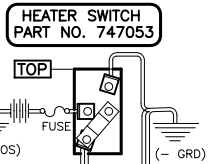
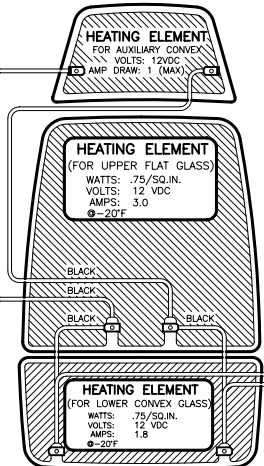
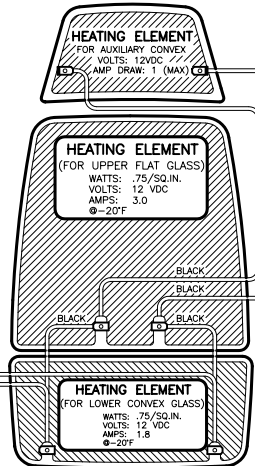

NO.	DESCRIPTION	VELVAC NO.	AMP NO.
1	9-WAY CAP HOUSING (FEMALE)	7476720	1-480707-0
2	9-WAY PLUG HOUSING (MALE)	7471340	1-480706-0
3	3-WAY CAP HOUSING (FEMALE)	7471240	1-480701-1
4	3-WAY PLUG HOUSING (MALE)	7471230	1-480700-0
5	2-WAY CAP HOUSING (FEMALE)	7471480	1-480699-0
6	2-WAY PLUG HOUSING (MALE)	7473890	1-480698-0
7	3-WAY CAP HOUSING (FEMALE)	7475600	925015-0
8	PIN TERMINAL (MALE)	7471270	350218-1
9	SOCKET TERMINAL (FEMALE)	7471280	350536-1
10	FEMALE RECEPTACLE		160655-2
11	6-WAY MINIATURE PLUG HOUSING	7476130	172168-1
12	6-WAY MINIATURE CAP HOUSING	7476120	172160-1
13	MINIATURE MALE PIN TERMINAL		770987-1
14	MINIATURE FEMALE PIN TERMINAL		770988-1

WIRING DIAGRAM FOR REMOTE CONTROL/HEATED FULL FLAT GLASS WITH TURN SIGNAL AND REMOTE/HEATED AUX. CONVEX GLASS

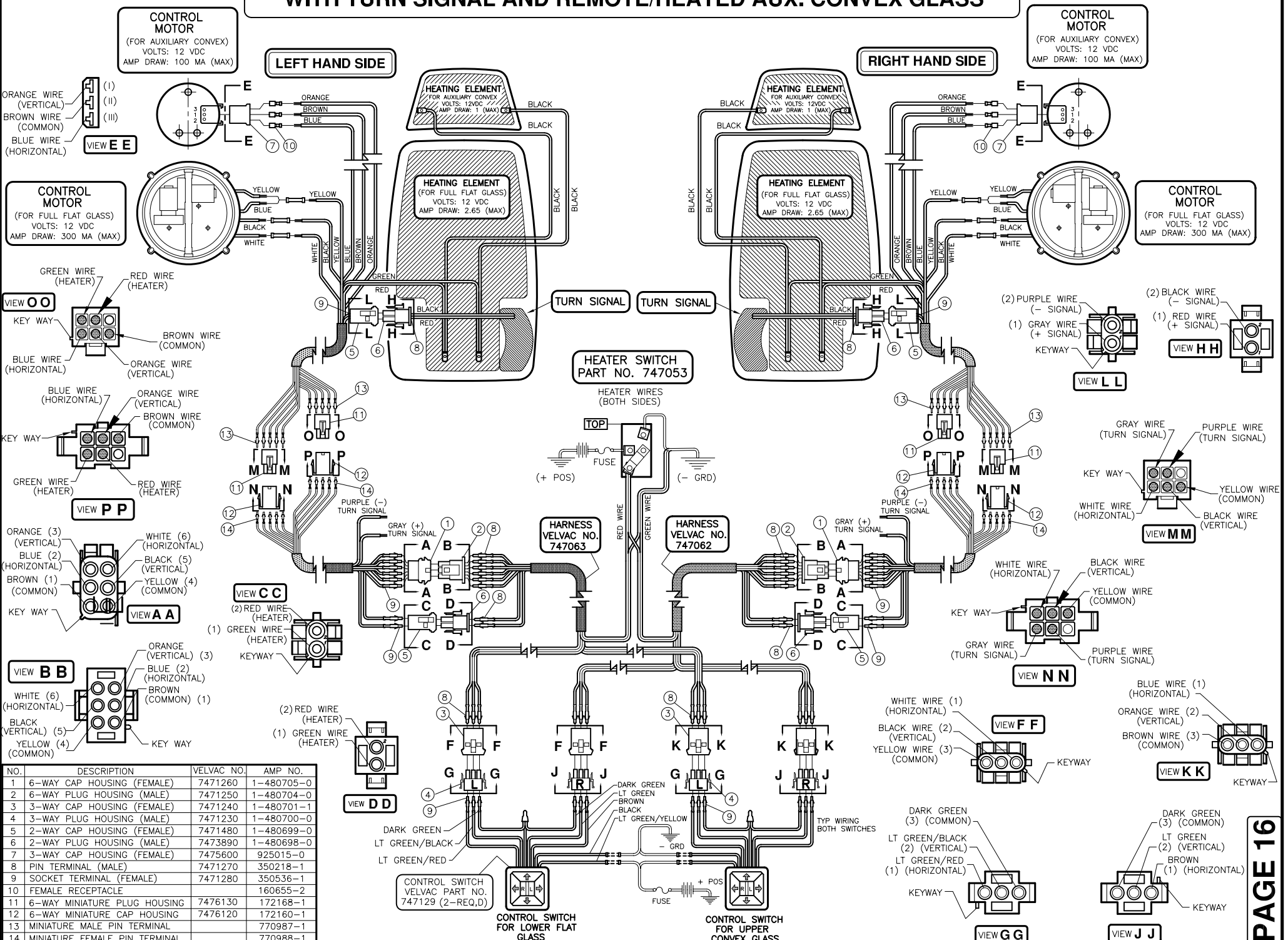

NO.	DESCRIPTION	VELVAC NO.	AMP NO.
1	6-WAY CAP HOUSING (FEMALE)	7471260	1-480705-0
2	6-WAY PLUG HOUSING (MALE)	7471250	1-480704-0
3	3-WAY CAP HOUSING (FEMALE)	7471240	1-480701-1
4	3-WAY PLUG HOUSING (MALE)	7471230	1-480700-0
5	2-WAY CAP HOUSING (FEMALE)	7471480	1-480699-0
6	2-WAY PLUG HOUSING (MALE)	7473890	1-480698-0
7	3-WAY CAP HOUSING (FEMALE)	7475600	925015-0
8	PIN TERMINAL (MALE)	7471270	350218-1
9	SOCKET TERMINAL (FEMALE)	7471280	350536-1
10	FEMALE RECEPTACLE		160655-2
11	6-WAY MINIATURE PLUG HOUSING	7476130	172168-1
12	6-WAY MINIATURE CAP HOUSING	7476120	172160-1
13	MINIATURE MALE PIN TERMINAL		770987-1
14	MINIATURE FEMALE PIN TERMINAL		770988-1

WIRING DIAGRAM FOR REMOTE CONTROL/HEATED FLAT GLASS AND REMOTE CONTROL/HEATED CONVEX GLASS

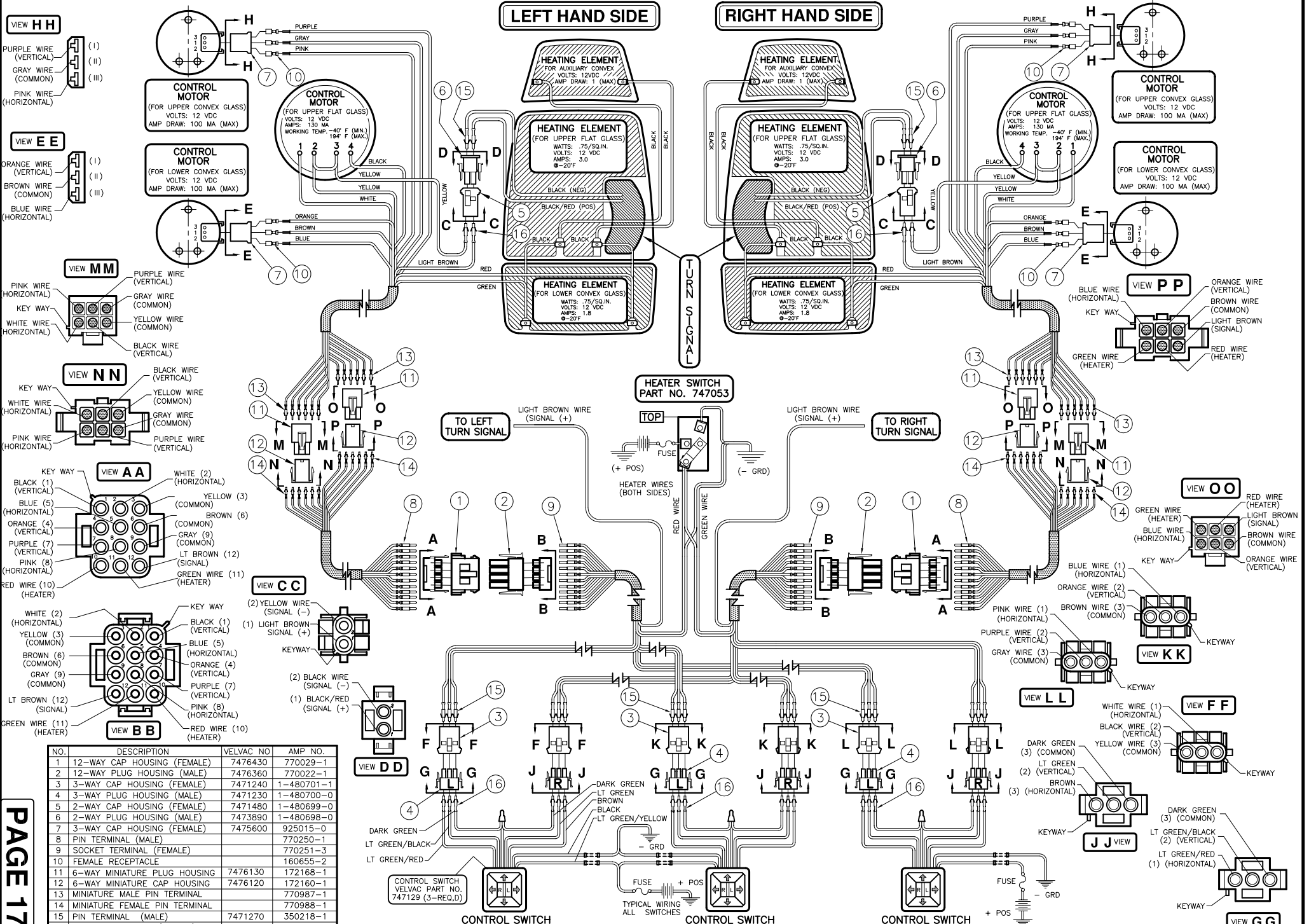

LEFT HAND SIDE

RIGHT HAND SIDE

CONTROL MOTOR
(FOR UPPER CONVEX GLASS)
VOLTS: 12 VDC
AMP DRAW: 100 MA (MAX)

CONTROL MOTOR
(FOR LOWER CONVEX GLASS)
VOLTS: 12 VDC
AMP DRAW: 100 MA (MAX)

CONTROL MOTOR
(FOR UPPER FLAT GLASS)
VOLTS: 12 VDC
AMPS: 130 MA
WORKING TEMP. -40° F (MIN.)
194° F (MAX.)

CONTROL MOTOR
(FOR LOWER FLAT GLASS)
VOLTS: 12 VDC
AMPS: 130 MA
WORKING TEMP. -40° F (MIN.)
194° F (MAX.)

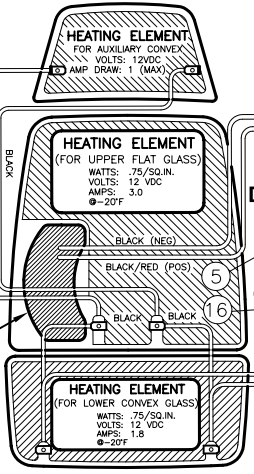
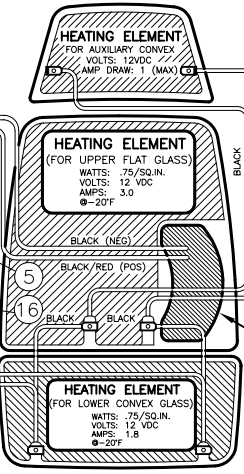

HEATER SWITCH
PART NO. 747053

TO LEFT TURN SIGNAL
LIGHT BROWN WIRE (SIGNAL +)

TO RIGHT TURN SIGNAL
LIGHT BROWN WIRE (SIGNAL +)

NO.	DESCRIPTION	VELVAC NO	AMP NO.
1	12-WAY CAP HOUSING (FEMALE)	7476430	770029-1
2	12-WAY PLUG HOUSING (MALE)	7476360	770022-1
3	3-WAY CAP HOUSING (FEMALE)	7471240	1-480701-1
4	3-WAY PLUG HOUSING (MALE)	7471230	1-480700-0
5	2-WAY CAP HOUSING (FEMALE)	7471480	1-480699-0
6	2-WAY PLUG HOUSING (MALE)	7473890	1-480698-0
7	3-WAY CAP HOUSING (FEMALE)	7475600	925015-0
8	PIN TERMINAL (MALE)		770250-1
9	SOCKET TERMINAL (FEMALE)		770251-3
10	FEMALE RECEPTACLE		160655-2
11	6-WAY MINIATURE PLUG HOUSING	7476130	172168-1
12	6-WAY MINIATURE CAP HOUSING	7476120	172160-1
13	MINIATURE MALE PIN TERMINAL		770987-1
14	MINIATURE FEMALE PIN TERMINAL		770988-1
15	PIN TERMINAL (MALE)	7471270	350218-1
16	SOCKET TERMINAL (FEMALE)	7471280	350536-1